

Soft-close dampening hinges in aluminium

Model : 75-1-0007



- Soft-close dampening hinge: soft-close damper keeps lid from slamming shut when the hinge is moved.
 - Damper working direction: shown by the arrow in the drawing.
 - Operating angle: 115°.
 - If the opening angle is wider than 115° (+/- 5°), mechanism is broken and damper doesn't work any longer.
 - Provide a door stopper to prevent from overturning beyond the prescribed angle range.
 - Do not force the door to close faster in damper effective direction. It can cause damage to the product.
 - When the door opening angle is small, the dampers may not work smoothly.
 - Torque moment (for one hinge): 2.5 to 4.5 N.m.
 - Torque calculation:
Torque (N.m) = L (m) x 1/2 x W (kg) x 9.8 with:
 - L = door height in metre.
 - W = door weight in kilo.
 - Operating temperature: 0 to +40°C.
 - Soft close of a door (vertical application): door closing system.
- Put together with a spring hinge with same dimension (72-1-4231 or 72-1-4232), an

automatic soft close of a door is possible without any other component.
Please ask us for more information.

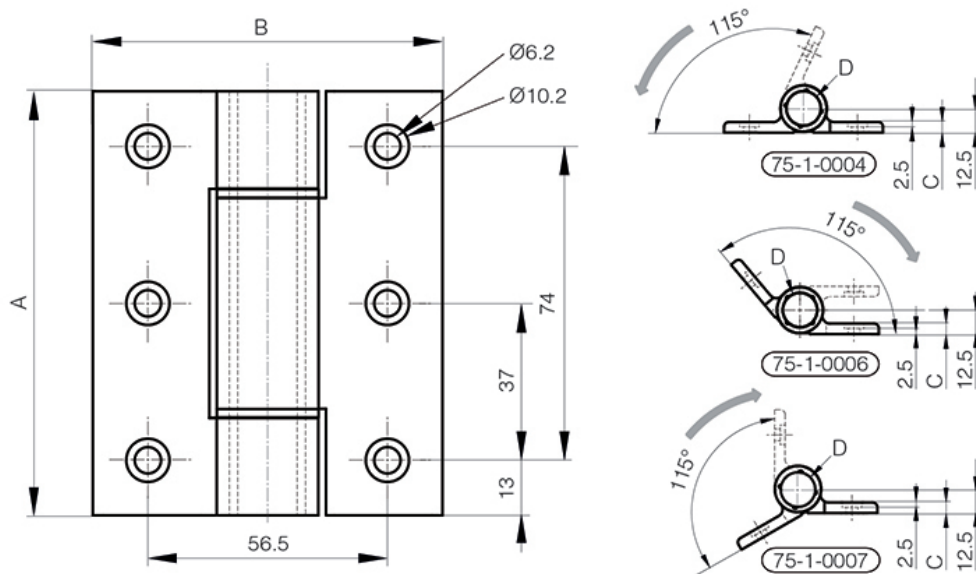

Material	6082 T5 alu
Finish	clear anodised
A (length)	100
D (pin diameter)	18
B (width)	82.5
C	5.5
Weight (g)	175
Opening angle	115
Note	Damper working direction for closing

Material	aluminium
Functions	torque damper
Torque	2.5 - 4.5 N.m