

Small FinAlu® hinges

Model : 72-1-4299



Small hinges in aluminium profile with a small pin diameter.
This nice design can be used in many applications:
(medical, electronic enclosures, food equipment, transportation...).

These drilled hinges have same features as FinAlu® continuous hinges.
They have the similar dimensions to hinges used in the aircraft industry.

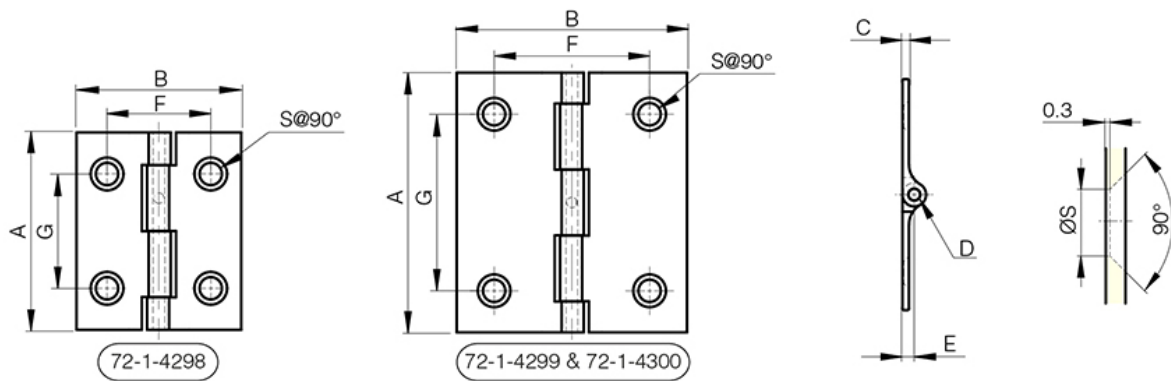

Material	6082 T5 alu
Finish	anodised
A (length)	50
B (width)	44.45
D (pin diameter)	2.29
C	1.3
E	2.29
Weight (g)	9
G (pitch)	34
F (pitch)	30
Opening angle	270
S	4.3
Material	aluminium
Functions	free swing hinges
Pin material	stainless steel